



PRODUCT CATALOGUE

A Company of the Group





WE DESIGN, WE PRODUCE, WE INNOVATE

A Company of the Group





Specialist wire processor and manufacturer of high-tech accessories for furniture sold through different channels such as industry, distribution and DIY. Compagnucci is a well-established player whose output reflects a strong commitment to investment in research, design and development. Farsighted strategies, rewarded with fifty years of unique achievements and a

prestige position on the international market, underlie an offering full of original, patented features, at the state of the art in quality and environmental certifications, and all in unmistakable Italian style.

The furniture sector and DIY, in strong and continuous expansion, are the divisions in which Compagnucci is the protagonist.





Great Numbers Great Value

FGV is the leading Italian manufacturer of furniture hardware and components. Since 1947 the company develops, produces and sells worldwide clever solutions for the furniture and kitchen industry at the right price. Over the years MADE IN FGV has become synonymous of Italian design combined with mass volume economies of scale. True to its slogan “Great Numbers, Great Value”, FGV offers to the market the right products in the right quality at the right price. With 7 production plants in Italy, Slovakia, Brazil and China working with the same quality standards, FGV has the tools to propose affordable solutions with the

latest technologies. Using state-of-the-art and cost efficient technology, FGV delivers a product portfolio which covers the needs of the industry. The FGV sales network of own subsidiaries is completed by a very performing net of strategic distributors to deliver modern furniture technology in every part of the world. Investing constantly in Customer service and new logistics solutions, FGV aim to help the furniture and kitchen industry to deliver an improved experience to the end-consumer when these buying and using furniture or kitchen cabinets.



Index



6

TECHNICAL SOLUTIONS



16

POLI-CRYSTAL LINE



24

POLI-OAK LINE



32

PREMIUM LINE

The pictures of the products on this catalogue are indicative and not binding. The real products might be aesthetically different from those pictured here.



46

COMFORT LINE



62

CLASSIC LINE



78

TIRAMIGIÙ



82

WASTE BINS



90

DISH DRAINERS

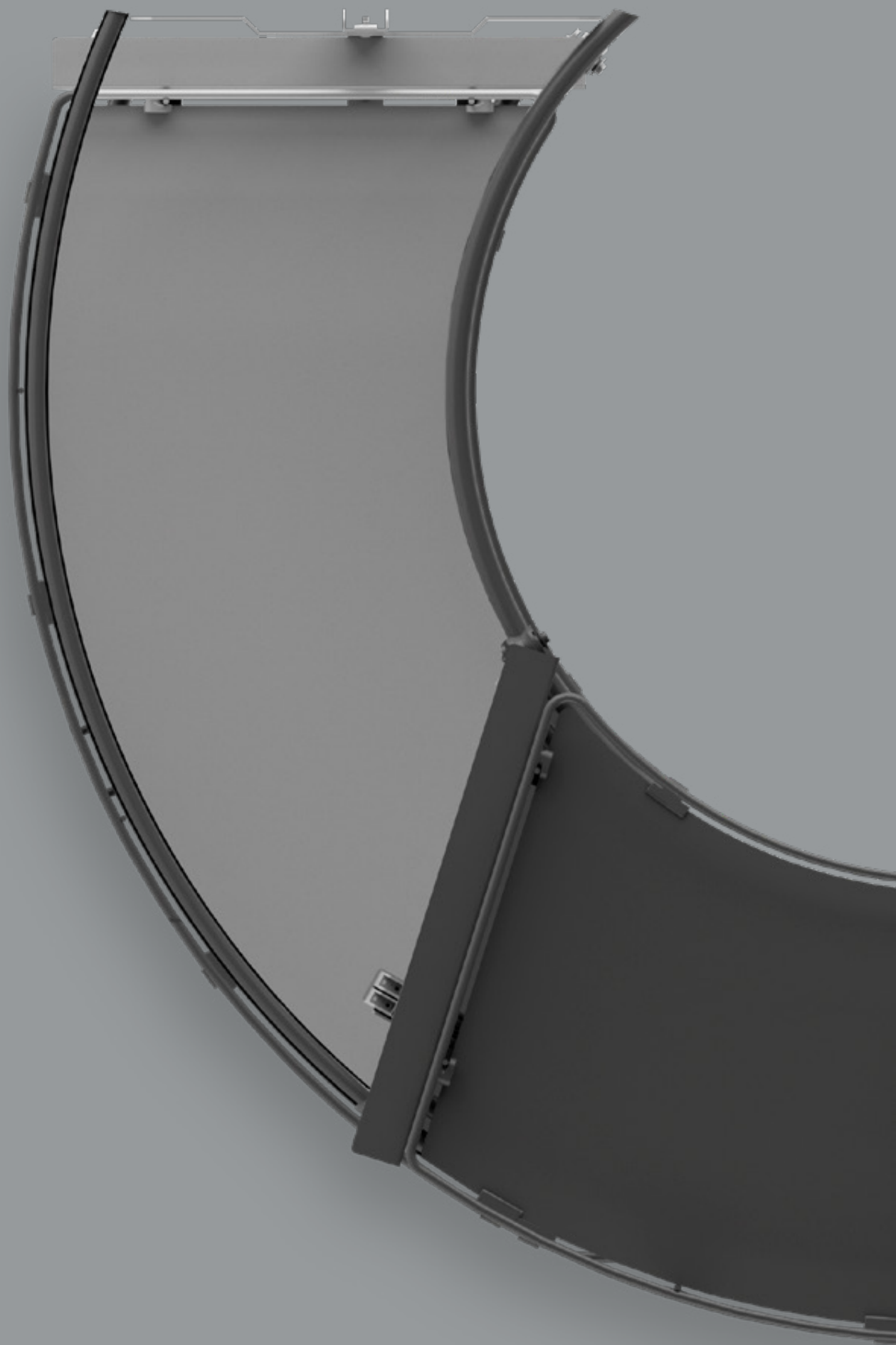

TECHNICAL SOLUTIONS

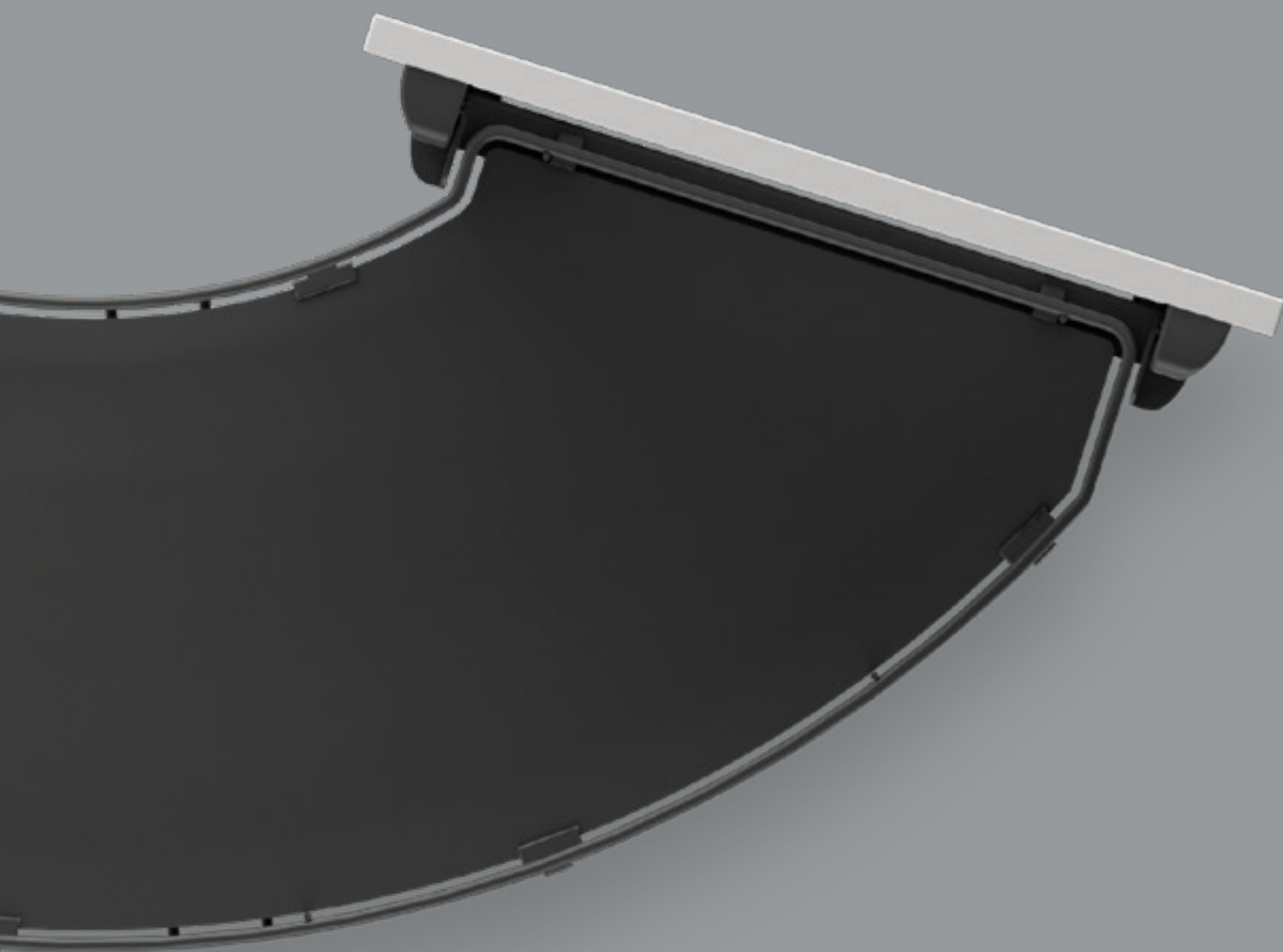

520/520P

Pull-out pantry

All the pull-out units are equipped with full extension runners with soft-close system.
The runner of the 520P model features a rack-and-pinion synchronization combined with the soft-open system.

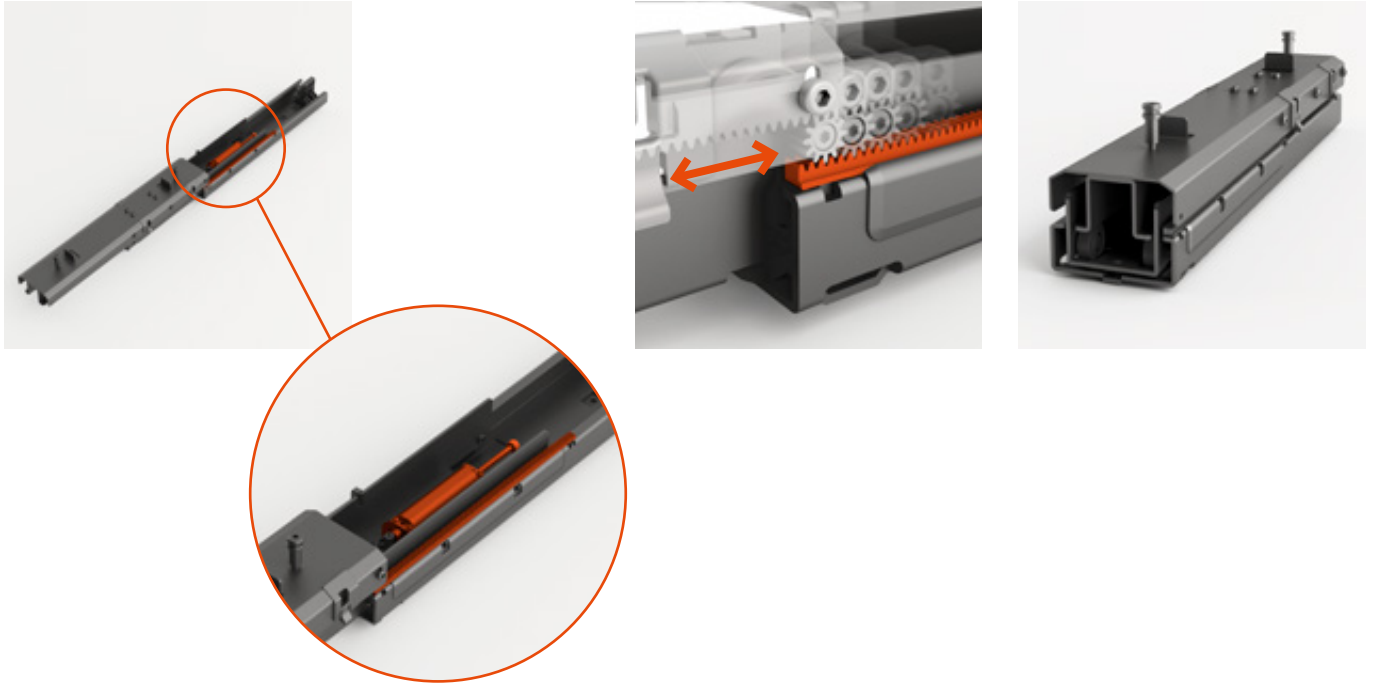

Three-dimensional adjustment of the door 520/520P



310/300

Swing-out larder

Double swing-out larder 310

Single swing-out larder 300



In the double swing-out larder the baskets on the door allow an easy reach of the content



In the single swing-out larder the baskets come out of the cabinet on opening of the door allowing an even easier access



The shelves can be fixed at different heights to optimize the space



Silent opening and closing movement

720 Girasolo

Corner pull-out shelves

Shelves motion on opening

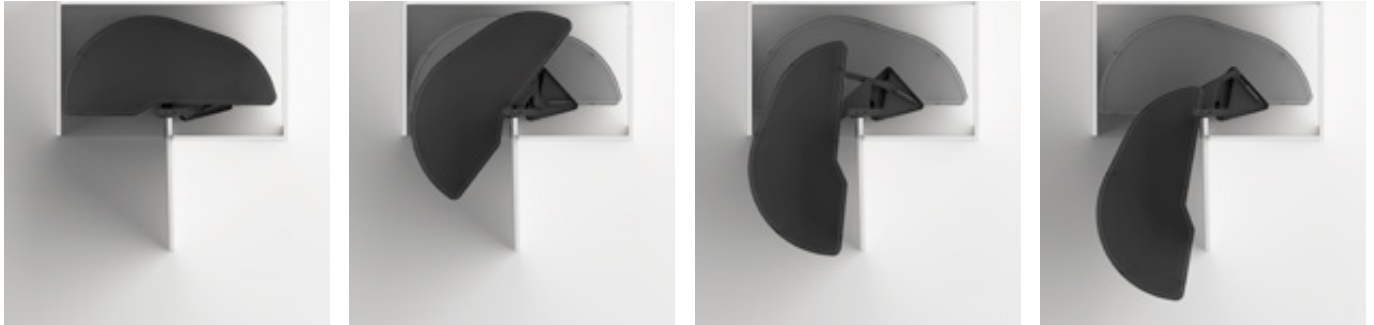

Easy installation with only 8 screws

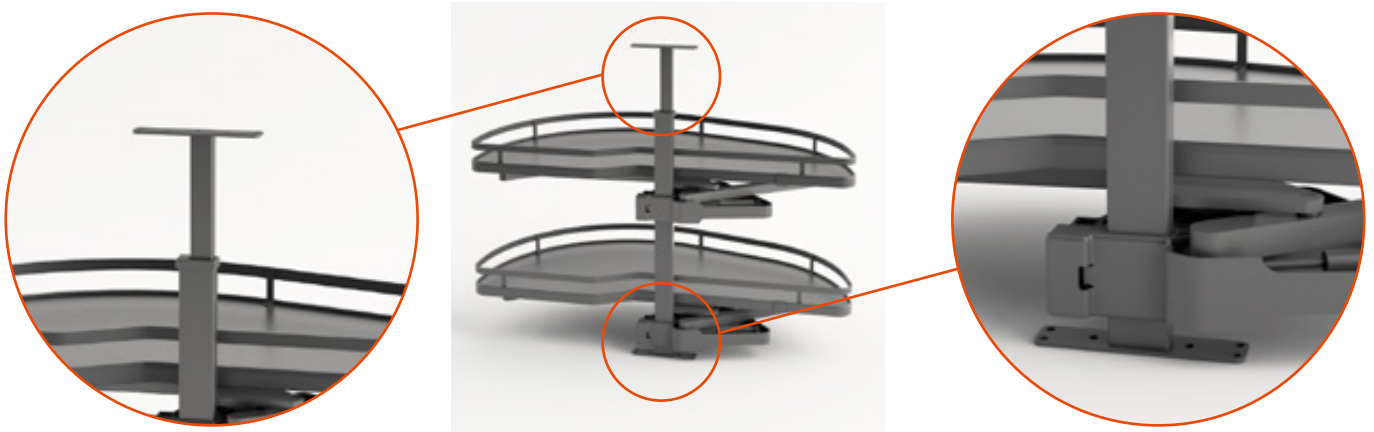

Adjustable height of the pole

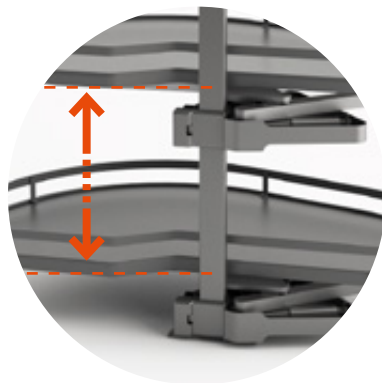

Height adjustable baskets



Soft-opening and closing system

599H/599/597

Corner mechanism

Mechanism motion on opening 599H/599



Three-dimensional adjustment of the door 599/597

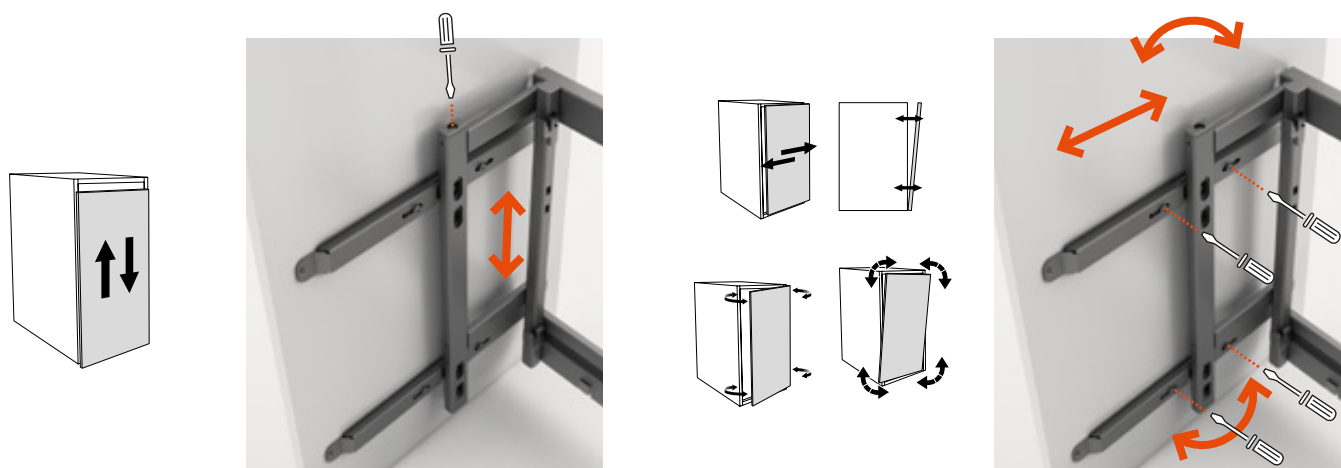

Mechanism with door brackets 599/597



Mechanism for hinged doors 599H



700 Twister

Shelves on curved runners for corner cabinets with door brackets

Shelves motion on opening

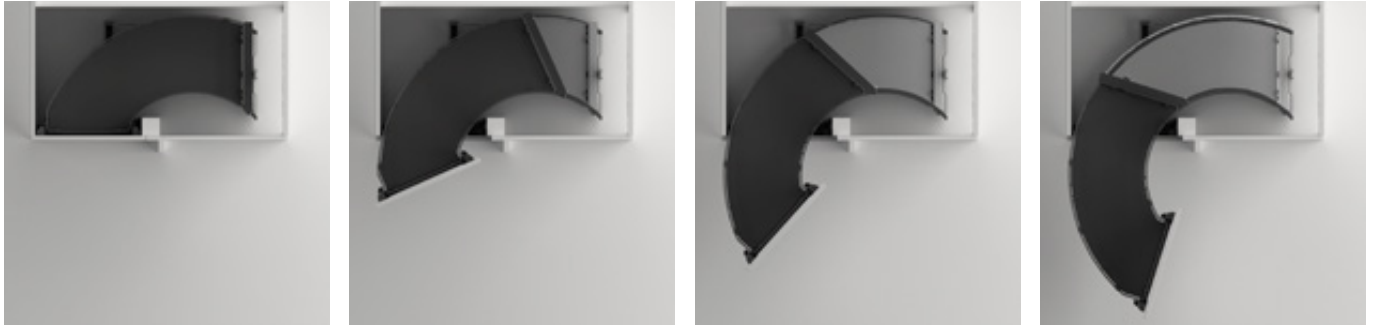

Fixing by brackets, three dimensional ajustement of the door

Mechanism for hinged doors

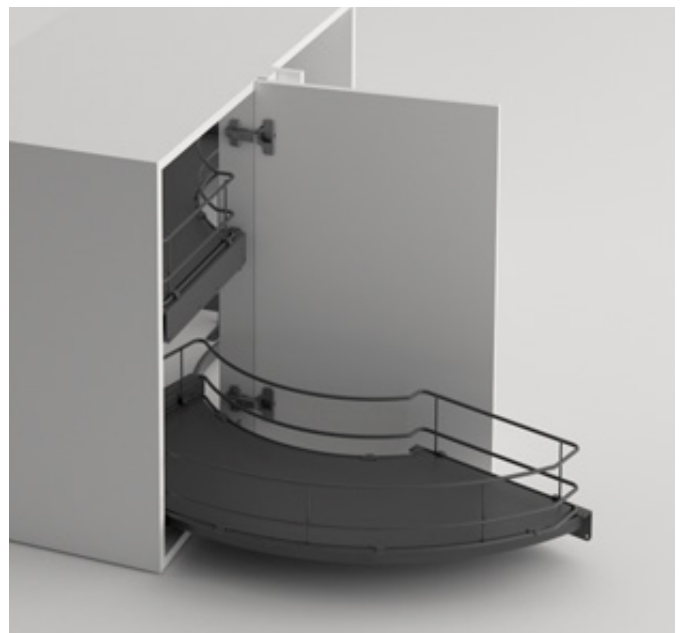
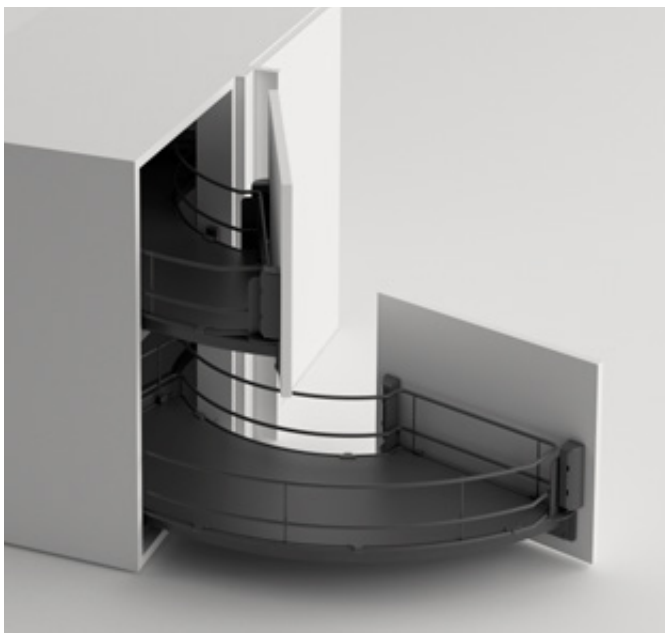

433

Base pull-out with side frame

Reversible, it can be mounted on the right or left side of the cabinet



Three-dimensional adjustment of the door

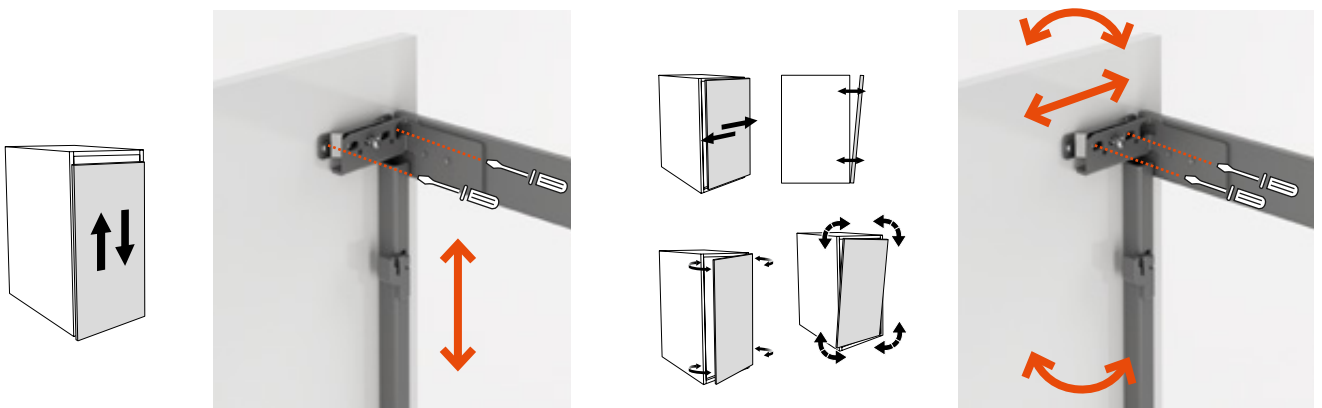

420

Base pull-out with middle frame

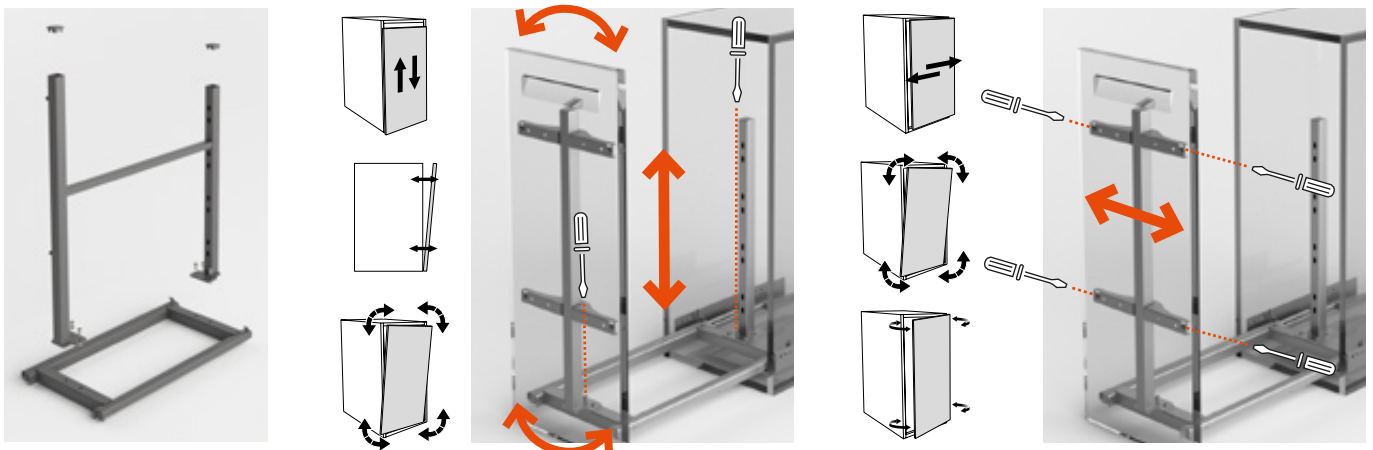

Frame disassembled to optimize space during transportation

Fixing position of the runners on the sides of the cabinet
Three-dimensional adjustment of the door

332/332P/332C

A complete product family for application on narrow cabinets

All products are equipped with three-dimensional adjustment of the door



Base cabinet



Wall cabinet



Tall cabinet

613/614

Base pull-out trolley with two shelves

All products are equipped with three-dimensional adjustment of the door



Fixing position of the runners on the bottom of the cabinet



Fixing position of the runners on the side of the cabinet



Application with bread bag with fixing position of the runners on the side of the cabinet

482

Pull-out drawer basket

Pull-out drawer basket with slides fixed on the sides of the cabinets for hinged doors



Door brackets with three-dimensional adjustments available on demand



485

Pull-out drawer basket for undersink cabinet





POLI-CRYSTAL LINE

The essentiality of glass combined with painted steel.
The will to mix these two elements to combine elegance
with pureness. A perfect blend suitable for kitchens that want
to extend their style also through internal accessories.



White



Grey



Orion

520/520P

Pull-out pantry



Full extension roller runners with soft close system
 Soft open system available (article 520P) on demand
 Three-dimensional adjustment of the door
 Total load capacity: 120 kg
 Maximum load per basket: 10 kg
 Installation depth: 494 mm (504 mm for 520P)

Art.	H (min-max)	Baskets	>□<	W
523	1130-1310	4	150	107
524	1310-1510	4	300	257
525	1510-1700	5	400	357
526	1700-1900	5	450	407
527	1900-2080	6		

Finishes available (baskets/side profiles/frame):

● White/Glass/White ● Grey/Glass/Grey ● Orion/Glass/Orion

599H

Double corner mechanism with inner pull-out baskets for hinged doors



Mechanism with high load capacity runner with soft-close system
 Internal basket runners with soft-close system
 Maximum load per basket: 9 kg (inner), 7 kg (outer)
 The upper external basket can be adjusted in height
 Installation depth: 505 mm
 Installation height: 670 mm
 Non-reversible product

>□<	W	K* (min-max)
450	405	860-1020
500	450	860-1020
600	550	945-1250

* K = cabinet internal width

Finishes available (baskets/side profiles/mechanism):

- White/Glass/White
- Grey/Glass/Grey
- Orion/Glass/Orion

599

Double corner mechanism with inner pull-out baskets with door brackets



Mechanism with high load capacity runner with soft-close system

Internal basket runners with soft-close system

Three-dimensional adjustment of the door

Maximum load per basket: 9 kg (inner), 7 kg (outer)

The upper external basket can be adjusted in height

Installation depth: 505 mm

Installation height: 670 mm

Non-reversible product

	W	K* (min-max)
450	405	860-1020
500	450	860-1020
600	550	945-1250

* K = cabinet internal width

Finishes available (baskets/side profiles/mechanism):

- White/Glass/White
- Grey/Glass/Grey
- Orion/Glass/Orion



433

Base pull-out with side frame



Full extension runners with soft-close system as standard
 Three-dimensional adjustment of the door
 Total load capacity: 20 kg
 Maximum load per basket: 10 kg
 Reversible, it can be mounted on the right or left side of the cabinet
 Installation depth: 489 mm
 Installation height: 636 mm

>□<	W
150	111
200	155
300	255

Finishes available (baskets/side profiles/frame):

- White/Glass/White
- Grey/Glass/Grey
- Orion/Glass/Orion

420

Base pull-out with central frame



Full extension runners with soft-close system as standard
 Three-dimensional adjustment of the door
 Total load capacity: 30 kg
 Maximum load per basket: 10 kg
 Fixing position of the runners on the cabinet sides
 Installation depth: 497 mm
 Installation height: 593 mm

>□<	w
300	264-268
400	364-368
450	414-418

Finishes available (baskets/side profiles/frame):

● White/Glass/White ● Grey/Glass/Grey ● Orion/Glass/Orion





POLI-OAK LINE

The charm of wood combined with painted steel.
The perfect combination suitable for any kitchen, from the most classic to the most modern one. The interior accessories give the kitchen a style that mixes the warmth of wood with the modernity of metal.



Orion

520/520P

Pull-out pantry



Full extension roller runners with soft close system
 Soft open system available (article 520P) on demand
 Three-dimensional adjustment of the door
 Total load capacity: 120 kg
 Maximum load per basket: 10 kg
 Installation depth: 494 mm (504 mm for 520P)

Art.	H (min-max)	Baskets	>□<	W
523	1130-1310	4	150	107
524	1310-1510	4	300	257
525	1510-1700	5	400	357
526	1700-1900	5	450	407
527	1900-2080	6		

Finishes available (baskets/side profiles/frame):

- Orion/Wood/Orion



599H

Double corner mechanism with inner pull-out baskets for hinged doors



Mechanism with high load capacity runner with soft-close system
 Internal basket runners with soft-close system
 Maximum load per basket: 9 kg (inner), 7 kg (outer)
 The upper external basket can be adjusted in height
 Installation depth: 505 mm
 Installation height: 670 mm
 Non-reversible product

>□<	W	K* (min-max)
450	405	860-1020
500	450	860-1020
600	550	945-1250

* K = cabinet internal width

Finishes available (baskets/side profiles/mechanism):

- Orion/Wood/Orion

599

Double corner mechanism with inner pull-out baskets with door brackets



Mechanism with high load capacity runner with soft-close system

Internal basket runners with soft-close system

Three-dimensional adjustment of the door

Maximum load per basket: 9 kg (inner), 7 kg (outer)

The upper external basket can be adjusted in height

Installation depth: 505 mm

Installation height: 670 mm

Non-reversible product

	W	K* (min-max)
450	405	860-1020
500	450	860-1020
600	550	945-1250

* K = cabinet internal width

Finishes available (baskets/side profiles/mechanism):

● Orion/Wood/Orion



433

Base pull-out with side frame



Full extension runners with soft-close system as standard
 Three-dimensional adjustment of the door
 Total load capacity: 20 kg
 Maximum load per basket: 10 kg
 Reversible, it can be mounted on the right or left side of the cabinet
 Installation depth: 489 mm
 Installation height: 636 mm

>□<	W
150	111
200	155
300	255

Finishes available (baskets/side profiles/frame):

- Orion/Wood/Orion

420

Base pull-out with central frame



Full extension runners with soft-close system as standard
 Three-dimensional adjustment of the door
 Total load capacity: 30 kg
 Maximum load per basket: 10 kg
 Fixing position of the runners on the cabinet sides
 Installation depth: 497 mm
 Installation height: 593 mm

>□<	w
300	264-268
400	364-368
450	414-418

Finishes available (baskets/side profiles/frame):

- Orion/Wood/Orion



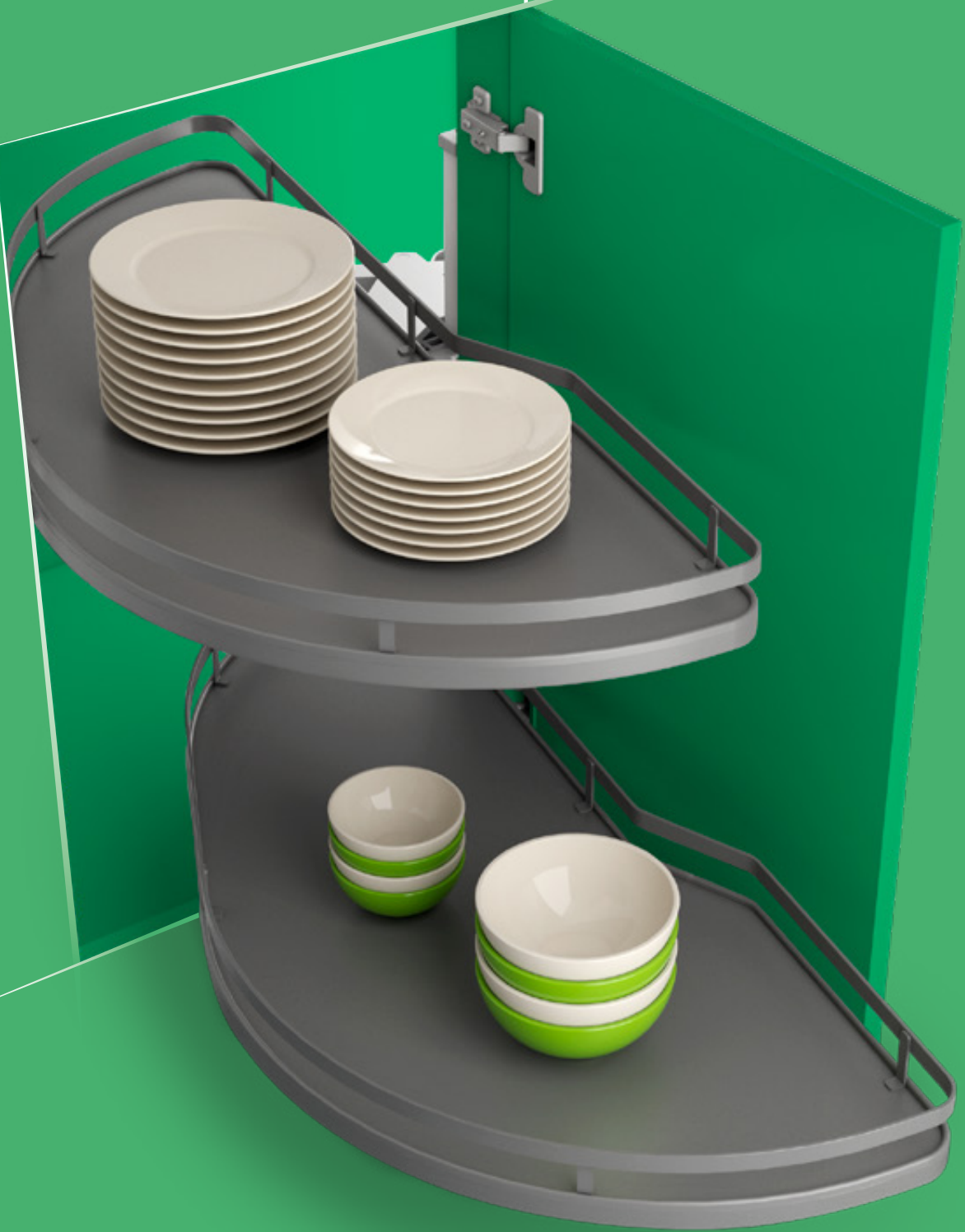

PREMIUM LINE

The reinterpretation of current aesthetics in a more modern key. The classic round wire becomes flat, giving the accessories a more elegant look. The bottom panel in HDF allows full advantage of the entire support surface of the baskets.



Chrome/White

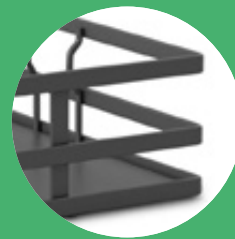

Orion/Orion

520/520P

Pull-out pantry



Full extension roller runners with soft close system
 Soft open system available (article 520P) on demand
 Three-dimensional adjustment of the door
 Total load capacity: 120 kg
 Maximum load per basket: 10 kg
 Installation depth: 494 mm (504 mm for 520P)

Art.	H (min-max)	Baskets	>□<	W
523	1130-1310	4	150	107
524	1310-1510	4	300	257
525	1510-1700	5	400	357
526	1700-1900	5	450	407
527	1900-2080	6	500	457
			600	557

Finishes available (baskets/bottom panel/frame):

● Chrome/White/Grey ● Orion/Orion/Orion



Single extension roller runners
 Total load capacity: 85 kg
 Maximum load per basket: 10 kg (inner), 5 kg (door)
 Installation depth: 495 mm
 Reversible, it can be mounted with doors opening to the right or to the left
 Works with hinges with a maximum opening angle of 115°

Art.	H	Baskets	>□<	W
313	1085	4+4	450	405
314	1405	5+5	500	455
316	1725	6+6	600	555

Finishes available (baskets/bottom panel/frame):

- Chrome/White/Grey
- Orion/Orion/Orion

300

Single swing-out larder



Single extension roller runners
 Total load capacity: 85 kg
 Maximum load per basket: 10 kg (inner)
 Installation depth: 495 mm
 Reversible, it can be mounted with doors opening to the right or to the left
 Works with hinges with a maximum opening angle of 115°

Art.	H	Baskets	>□<	W
304	1405	4	450	405
306	1725	5	500	455
			600	555

Finishes available (baskets/bottom panel/frame):

● Chrome/White/Grey ● Orion/Orion/Orion



332C

Pantry pull-out unit for narrow cabinets



Full extension runners with soft close system
 Three-dimensional adjustment of the door
 Total load capacity: 30 kg
 Equipped with three runners on the left side of the cabinet
 Installation depth: 480 mm

Art.	H	Baskets	>□<	W
332C-5	1495	5	150	111
332C-6	1880	6	200	161

Finishes available (baskets/bottom panel):

- Chrome/White
- Orion/Orion

720 Girasolo

Corner pull-out shelves



Mechanism equipped with soft-close and soft-open system as standard
 Total load capacity: 40 kg
 Maximum load per basket: 20 kg
 Shelves can be adjusted in height
 Installation depth: 460 mm (depending on the construction of the cabinet)
 Installation height (min-max): 620-780 mm
 Non-reversible product

>□<	W	K*
400	360	760
450	410	860
500	460	960
600	560	960

* K = cabinet internal width

Finishes available (baskets/bottom panel/mechanism):

● Chrome/White/Grey ● Orion/Orion/Grey



599H

Double corner mechanism with inner pull-out baskets for hinged doors



Mechanism with high load capacity runner with soft-close system

Internal basket runners with soft-close system

Maximum load per basket: 9 kg (inner), 7 kg (outer)

The upper external basket can be adjusted in height

Installation depth: 505 mm

Installation height: 670 mm

Non-reversible product

>□<	W	K* (min-max)
450	405	860-1020
500	450	860-1020
600	550	945-1250

* K = cabinet internal width

Finishes available (baskets/bottom panel/mechanism):

- Chrome/White/Grey
- Orion/Orion/Orion

599

Double corner mechanism with inner pull-out baskets with door brackets



Mechanism with high load capacity runner with soft-close system
 Internal basket runners with soft-close as standard
 Three-dimensional adjustment of the door
 Maximum load per basket: 9 kg (inner), 7 kg (outer)
 The upper external basket can be adjusted in height
 Installation depth: 505 mm
 Installation height: 670 mm
 Non-reversible product

	W	K* (min-max)
450	405	860-1020
500	450	860-1020
600	550	945-1250

* K = cabinet internal width

Finishes available (baskets/bottom panel/mechanism):

● Chrome/White/Grey ● Orion/Orion/Orion



597

Double corner mechanism with inner fixed baskets with door brackets



Mechanism with high load capacity runner with soft-close system

Three-dimensional adjustment of the door

Maximum load per basket: 9 kg (inner), 7 kg (outer)

The upper external basket can be adjusted in height

Installation depth: 485 mm

Installation height: 615 mm

Non-reversible product

	W	K* (min-max)
400	350	760-930
450	400	860-1020
500	450	890-1020
600	550	945-1270

* K = cabinet internal width

Finishes available (baskets/bottom panel/mechanism):

- Chrome/White/Grey
- Orion/Orion/Orion

332

Base pull-out for narrow cabinets



Full extension runners with soft close system
 Three-dimensional adjustment of the door
 Total load capacity: 30 kg
 Possibility to have the runners on the left, on the right side or crossed
 Installation depth: 480 mm
 Installation height: 525 mm

>□<	w
150	107
200	157

Finishes available (baskets/bottom panel):

- Chrome/White
- Orion/Orion



613

Base pull-out trolley with two baskets



Full extension runners with soft close system
 Three-dimensional adjustment of the door
 Total load capacity: 30 kg
 Fixing position of the runners on the sides of the cabinet
 Installation depth: 480 mm
 Installation height: 506 mm

>□<	w
300	264-268
400	364-368
450	414-418

Finishes available (baskets/bottom panel):

- Chrome/White
- Orion/Orion

614

Base pull-out trolley with bread bag



Full extension runners with soft close system
 Three-dimensional adjustment of the door
 Total load capacity: 30 kg
 Fixing position of the runners on the sides of the cabinet
 Installation depth: 480 mm
 Installation height: 506 mm

>□<	w
300	264-268
400	364-368
450	414-418

Finishes available (baskets/bottom panel):

- Chrome/White
- Orion/Orion



482

Pull-out drawer basket



Full extension runners with soft close system
 Total load capacity: 30 kg
 Installation depth: 490 mm
 Installation height: 120 mm

>□<	w
450	414-418
600	564-568
900	864-868

Finishes available (baskets/bottom panel):

- Chrome/White
- Orion/Orion

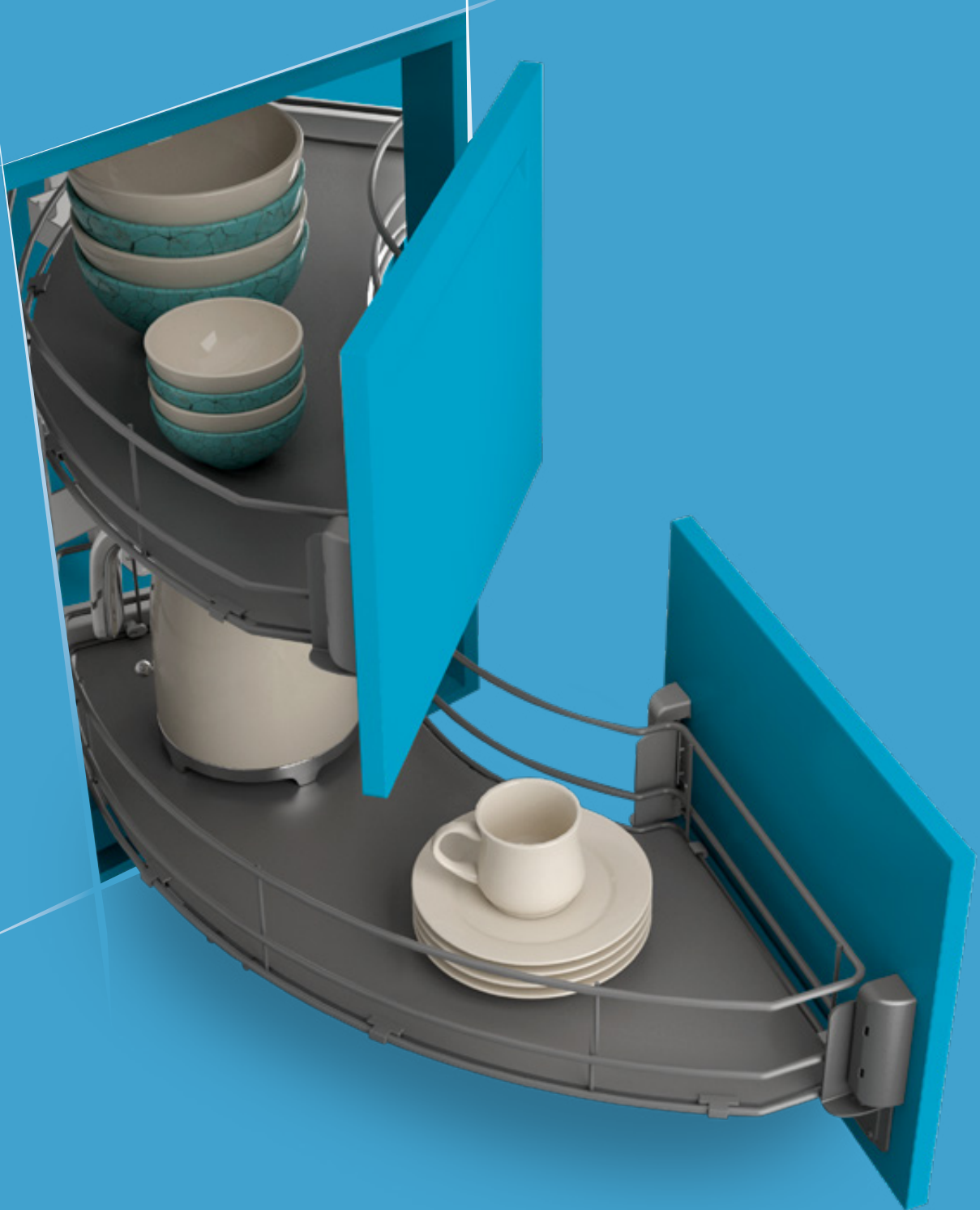

COMFORT LINE

The convenience of having the bottom panels in HDF combined with the classic shape of the basket made of round wire. Accessories that meet the most varied needs with solutions suitable for any type of furniture.



Grey/Grey



Chrome/Grey



Chrome/White



Orion/Orion

520/520P

Pull-out pantry



Full extension roller runners with soft close system
 Soft open system available (article 520P) on demand
 Three-dimensional adjustment of the door
 Total load capacity: 120 kg
 Maximum load per basket: 10 kg
 Installation depth: 494 mm (504 mm for 520P)

Art.	H (min-max)	Baskets	>□<	W
523	1130-1310	4	150	107
524	1310-1510	4	300	257
525	1510-1700	5	400	357
526	1700-1900	5	450	407
527	1900-2080	6	500	457
			600	557

Finishes available (basket/bottom panel/frame):

- Grey/Grey/Grey
- Chrome/Grey/Grey
- Chrome/White/Grey
- Orion/Orion/Orion



Single extension roller runners
 Total load capacity: 85 kg
 Maximum load per basket: 10 kg (inner), 5 kg (door)
 Installation depth: 495 mm
 Reversible, it can be mounted with doors opening to the right or to the left
 Works with hinges with a maximum opening angle of 115°

Art.	H (min-max)	Baskets	>□<	W
313	1085	4+4	450	405
314	1405	5+5	500	455
316	1725	6+6	600	555

Finishes available (basket/bottom panel/frame):

● Grey/Grey/Grey

● Chrome/Grey/Grey

● Chrome/White/Grey

● Orion/Orion/Orion

300

Single swing-out larder



Single extension roller runners
 Total load capacity: 85 kg
 Maximum load per basket: 10 kg (inner)
 Installation depth: 495 mm
 Reversible, it can be mounted with doors opening to the right or to the left
 Works with hinges with a maximum opening angle of 115°

Art.	H	Baskets	>□<	W
304	1405	4	450	405
306	1725	5	500	455
			600	555

Finishes available (basket/bottom panel/frame):

- Grey/Grey/Grey
- Chrome/Grey/Grey
- Chrome/White/Grey
- Orion/Orion/Orion



332C

Pantry pull-out unit for narrow cabinets



Full extension runners with soft close system
 Three-dimensional adjustment of the door
 Total load capacity: 30 kg
 Equipped with three runners on the left side of the cabinet
 Equipped with bottle holder dividers
 Installation depth: 480 mm

Art.	H	Baskets	>□<	W
332C-5	1495	5	150	111
332C-6	1880	6	200	161

Finishes available (basket/bottom panel):

● Grey/Grey

● Chrome/Grey

● Chrome/White

● Orion/Orion

720 Girasolo

Corner pull-out shelves



Mechanism equipped with soft-close and soft-open system as standard
 Total load capacity: 40 kg
 Maximum load per basket: 20 kg
 Shelves can be adjusted in height
 Installation depth: 460 mm (depending on the construction of the cabinet)
 Installation height (min-max): 620-780 mm
 Non-reversible product

>□<	W	K*
400	360	760
450	410	860
500	460	960
600	560	960

* K = cabinet internal width

Finishes available (basket/bottom panel/mechanism):

● Chrome/White/Grey ● Orion/Orion/Grey



599H

Double corner mechanism with inner pull-out baskets for hinged doors



Mechanism with high load capacity runner with soft-close system

Internal basket runners with soft-close system

Maximum load per basket: 9 kg (inner), 7 kg (outer)

The upper external basket can be adjusted in height

Installation depth: 505 mm

Installation height: 670 mm

Non-reversible product

>□<	W	K* (min-max)
450	405	860-1020
500	450	860-1020
600	550	945-1250

* K = cabinet internal width

Finishes available (baskets/bottom panel/mechanism):

● Grey/Grey/Grey

● Chrome/Grey/Grey

● Chrome/White/Grey

● Orion/Orion/Orion

599

Double corner mechanism with inner pull-out baskets with door brackets



Mechanism with high load capacity runner with soft-close system
 Internal basket runners with soft-close
 Three-dimensional adjustment of the door
 Maximum load per basket: 9 kg (inner), 7 kg (outer)
 The upper external basket can be adjusted in height
 Installation depth: 505 mm
 Installation height: 670 mm
 Non-reversible product

	W	K* (min-max)
450	405	860-1020
500	450	860-1020
600	550	945-1250

* K = cabinet internal width

Finishes available (baskets/bottom panel/mechanism):

- Grey/Grey/Grey
- Chrome/Grey/Grey
- Chrome/White/Grey
- Orion/Orion/Orion

Double corner mechanism with inner fixed baskets with door brackets



Mechanism with high load capacity runner with soft-close system

Three-dimensional adjustment of the door

Maximum load per basket: 9 kg (inner), 7 kg (outer)

The upper external basket can be adjusted in height

Installation depth: 485 mm

Installation height: 615 mm

Non-reversible product

	W	K* (min-max)
400	350	760-930
450	400	860-1020
500	450	890-1020
600	550	945-1270

* K = cabinet internal width

Finishes available (baskets/bottom panel/mechanism):

● Grey/Grey/Grey

● Chrome/Grey/Grey

● Chrome/White/Grey

● Orion/Orion/Orion

700 Twister

Shelves on curved runners for corner cabinets with door brackets



Mechanism equipped with soft close system
 Three-dimensional adjustment of the door
 Maximum load per basket: 15 kg
 The shelves can be adjusted in height
 Installation depth: 500 mm
 Installation height: 515 mm
 Non-reversible product

>□<	W	K*
450	412	864
500	462	895
600	512	940

* K = cabinet internal width

Finishes available (baskets/bottom panel/mechanism):

- Grey/Grey/Grey
- Chrome/Grey/Grey
- Chrome/White/Grey
- Orion/Orion/Orion



332/332S

Base pull-out for narrow cabinets



Full extension runners with soft close system (332)
 Single extension runners with soft close system (332S)
 Three-dimensional adjustment of the door
 Total load capacity: 30 kg (332), 25 kg (332S)
 Possibility to have the runners on the left, on the right side or crossed
 Bottle holder dividers available on demand
 Wall-cabinet version available on demand

Art.	D	H	>□<	W
332	480	525	150	107
332S	490	520	200	157

Finishes available (baskets/bottom panel):

● Grey/Grey

● Chrome/Grey

● Chrome/White

● Orion/Orion

613/613S

Base pull-out trolley with two baskets



Full extension runners with soft close system (613)
 Single extension runners with soft close system (613S)
 Three-dimensional adjustment of the door
 Total load capacity: 30 kg (613), 25 kg (613S)
 Fixing position of the runners on the sides of the cabinet
 Equipped with bottle holder dividers

Art.	D	H	>□<	W
613	480	506	300	264-268
613S	490	506	400	364-368
			450	414-418
			500	464-468
			600	564-568

Finishes available (baskets/bottom panel):

● Grey/Grey

● Chrome/Grey

● Chrome/White

● Orion/Orion



614/614S

Base pull-out trolley with bread bag



Full extension runners with soft close system (614)
 Single extension runners with soft close system (614S)
 Three-dimensional adjustment of the door
 Total load capacity: 30 kg (614), 25 kg (614S)
 Fixing position of the runners on the sides of the cabinet
 Equipped with bottle holder dividers

Art.	D	H	>□<	W
614	480	506	300	264-268
614S	490	506	400	364-368
			450	414-418

Finishes available (baskets/bottom panel):

● Grey/Grey

● Chrome/Grey

● Chrome/White

● Orion/Orion

482

Pull-out drawer basket



Full extension runners with soft close system
 Total load capacity: 30 kg
 Installation depth: 490 mm
 Installation height: 120 mm
 Door brackets with three-dimensional adjustments available on demand

>□<	w
450	414-418
600	564-568
900	864-868

Finishes available (baskets/bottom panel):

● Grey/Grey

● Chrome/Grey

● Chrome/White

● Orion/Orion



485

Pull-out drawer basket for undersink cabinet



Full extension runners with soft close system

Total load capacity: 30 kg

Installation depth: 490 mm

Installation height: 120 mm

Door brackets with three-dimensional adjustments available on demand

>□<	w
800	764-768
900	864-868
1000	964-968
1200	1164-1168

Finishes available (baskets/bottom panel):

● Grey/Grey

● Chrome/Grey

● Chrome/White

● Orion/Orion



CLASSIC LINE

Wire baskets that continue to be true classics that overcome the pitfalls of time. A perfect combination of simplicity, quality and practicality. Their transparency, thanks to the wire bottom, makes everyday life in the kitchen easier.



Grey

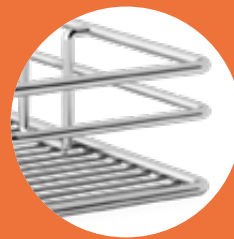

Chrome



Orion

520/520P

Pull-out pantry



Full extension roller runners with soft close system
 Soft open system available (article 520P) on demand
 Three-dimensional adjustment of the door
 Total load capacity: 120 kg
 Maximum load per basket: 10 kg
 Installation depth: 494 mm (504 mm for 520P)

Art.	H (min-max)	Baskets	>□<	W
523	1130-1310	4	150	107
524	1310-1510	4	300	257
525	1510-1700	5	400	357
526	1700-1900	5	450	407
527	1900-2080	6	500	457
			600	557

Finishes available (baskets/frame):

- Grey/Grey
- Chrome/Grey
- Orion/Orion



310

Double swing-out larder



Single extension roller runners
 Total load capacity: 85 kg
 Maximum load per basket: 10 kg (inner), 5 kg (door)
 Installation depth: 495 mm
 Reversible, it can be mounted with doors opening to the right or to the left
 Works with hinges with a maximum opening angle of 115°

Art.	H (min-max)	Baskets	>□<	W
313	1085	4+4	450	405
314	1405	5+5	500	455
316	1725	6+6	600	555

Finishes available (baskets/frame):

- Grey/Grey
- Chrome/Grey
- Orion/Orion

300

Single swing-out larder



Single extension roller runners
 Total load capacity: 85 kg
 Maximum load per basket: 10 kg (inner)
 Installation depth: 495 mm
 Reversible, it can be mounted with doors opening
 to the right or to the left
 Works with hinges with a maximum opening angle of 115°

Art.	H	Baskets	>□<	W
304	1405	4	450	405
306	1725	5	500	455
			600	555

Finishes available (baskets/frame):

- Grey/Grey
- Chrome/Grey
- Orion/Orion



599H

Double corner mechanism with inner pull-out baskets for hinged doors



Mechanism with high load capacity runner with soft-close system

Internal basket runners with soft-close system

Maximum load per basket: 9 kg (inner), 7 kg (outer)

The upper external basket can be adjusted in height

Installation depth: 505 mm

Installation height: 670 mm

Non-reversible product

>□<	W	K* (min-max)
450	405	860-1020
500	450	860-1020
600	550	945-1250

* K = cabinet internal width

Finishes available (baskets/mechanism):

● Grey/Grey

● Chrome/Grey

● Orion/Orion

599

Double corner mechanism with inner pull-out baskets with door brackets



Mechanism with high load capacity runner with soft-close system
 Internal basket runners with soft-close
 Three-dimensional adjustment of the door
 Maximum load per basket: 9 kg (inner), 7 kg (outer)
 The upper external basket can be adjusted in height
 Installation depth: 505 mm
 Installation height: 670 mm
 Non-reversible product

>□<	W	K* (min-max)
450	405	860-1020
500	450	860-1020
600	550	945-1250

* K = cabinet internal width

Finishes available (baskets/mechanism):

● Grey/Grey

● Chrome/Grey

● Orion/Orion

Double corner mechanism with inner fixed baskets with door brackets



Mechanism with high load capacity runner with soft-close

Three-dimensional adjustment of the door

Maximum load per basket: 9 kg (inner), 7 kg (outer)

The upper external basket can be adjusted in height

Installation depth: 485 mm

Installation height: 615 mm

Non-reversible product

>□<	W	K* (min-max)
400	350	760-930
450	400	860-1020
500	450	890-1020
600	550	945-1270

* K = cabinet internal width

Finishes available (baskets/mechanism):

● Grey/Grey

● Chrome/Grey

● Orion/Orion

378

Half-moon carousels



Shelves in shock-resistant polystyrene
 Maximum load per shelf: 10 kg
 The product is connected to the vertical post of the cabinet
 The shelves can be adjusted in height
 The lower shelf can be connected to the door
 Installation height: 130 mm (for each shelf)
 Left/right reversible product

Art.	W	K*	D
Ø70	360	710	365
Ø75	410	760	390

* K = cabinet internal width

Finishes available (railing/shelf):

- Grey/Grey
- Chrome/Grey
- Orion/Orion



Shelves in shock-resistant polystyrene
 Maximum load per shelf: 10 kg
 The product is connected to the bottom of the cabinet
 The shelves can be adjusted in height
 The shelves are equipped with a locking system in the closed position
 Installation height: 495 mm

Art.	K*
Ø70	760x760
Ø80	860x860

* K = cabinet internal dimensions

Finishes available (railing/shelf):

- Grey/Grey
- Chrome/Grey
- Orion/Orion

332/332S

Base pull-out for narrow cabinets



Full extension runners with soft close system (332)
 Single extension runners with soft close system (332S)
 Three-dimensional adjustment of the door
 Total load capacity: 30 kg (332), 25 kg (332S)
 Possibility to have the runners on the left, on the right side or crossed
 Bottle holder dividers available on demand
 Wall-cabinet version available on demand

Art.	D	H	>□<	W
332	480	525	150	107
332S	490	520	200	157

Finishes available (baskets):

● Grey ● Chrome ● Orion



613/613S

Base pull-out trolley with two baskets



Full extension runners with soft close system (613)
 Single extension runners with soft close system (613S)
 Three-dimensional adjustment of the door
 Total load capacity: 30 kg (613), 25 kg (613S)
 Fixing position of the runners on the bottom of the cabinet
 Equipped with bottle holder dividers

Art.	D	H	>□<	W
613	480	506	300	245
613S	490	506	400	345
			450	395

Finishes available (baskets):

● Grey

● Chrome

● Orion

614/614S

Base pull-out trolley with bread bag



Full extension runners with soft close system (614)
 Single extension runners with soft close system (614S)
 Three-dimensional adjustment of the door
 Total load capacity: 30 kg (614), 25 kg (614S)
 Fixing position of the runners on the bottom of the cabinet
 Equipped with bottle holder dividers

Art.	D	H	>□<	W
614	480	506	300	245
614S	490	506	400	345
			450	395

Finishes available (baskets):

● Grey ● Chrome ● Orion



482

Pull-out drawer basket



Full extension runners with soft close system
 Total load capacity: 30 kg
 Installation depth: 490 mm
 Installation height: 120 mm
 Door brackets with three-dimensional adjustments available on demand

>□<	w
450	414-418
600	564-568
900	864-868

Finishes available (baskets):

● Grey

● Chrome

● Orion

485

Pull-out drawer basket for undersink cabinet



Full extension runners with soft close system
 Total load capacity: 30 kg
 Installation depth: 490 mm
 Installation height: 120 mm
 Door brackets with three-dimensional adjustments available on demand

>□<	w
800	764-768
900	864-868
1000	964-968
1200	1164-1168

Finishes available (baskets):

- Grey
- Chrome
- Orion



Single extension runners
 Total load capacity: 15 kg
 Installation width: 270 mm
 Installation depth: 450 mm
 Installation height: 450 mm
 Reversible, it can be mounted on the right or left side of the cabinet

Finishes available (baskets)

- Grey
- Chrome
- Orion



TIRAMIGIÙ

An element that allows what is stored in the wall unit to move down to the worktop for an easy grasp on what is contained therein. It improves the overview and makes it easier and faster access to what is stored in cabinet.

826-1

Wall pull-down mechanism with one shelf



Stable movement with soft-close system as standard

Patented locking system on opening

Total load capacity: 8 kg

Installation height: 485 mm

Installation depth: 280 mm

>□<	w
500	464-468
600	564-568
800	764-768
900	864-868

Finishes available (shelves/mechanism):

- Orion/Orion



826-2

Wall pull-down mechanism with two shelves



Stable movement with soft-close system as standard

Patented locking system on opening

Total load capacity: 8 kg

Installation height: 630 mm

Installation depth: 280 mm

>□<	w
500	464-468
600	564-568
800	764-768
900	864-868

Finishes available (shelves/mechanism):

- Orion/Orion

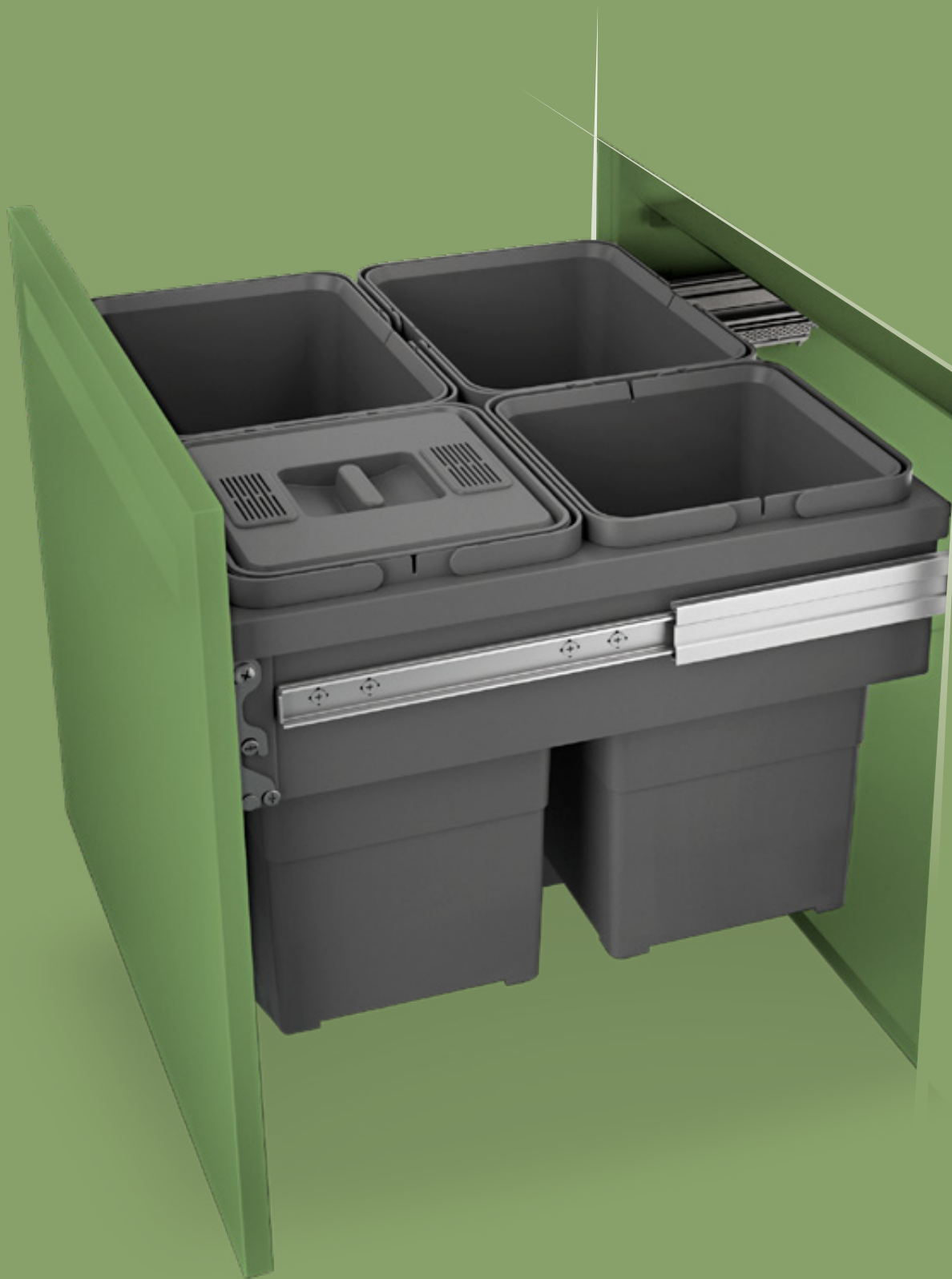

WASTE BINS

Systems and solutions dedicated to the separate waste collection that allow for optimal, efficient and personalized domestic management thanks to the different storage capacities proposed.

269 H53

High capacity pull-out waste bin



Heavy duty ball bearing runners with soft-close system as standard
 Three-dimensional adjustment of the door
 Upper shelf in painted steel available as option
 Lid with filter available as option
 Total load capacity: 60 kg
 Installation depth: 485 mm
 Installation height: 570 mm

Finishes available (bins/frame):

- Orion/Orion

>□<	300	400	450	500	600
W	264-268	364-368	414-418	464-468	564-568
TOT	35 L	35 L	70 L	70 L	86 L



269 H44

High capacity pull-out waste bin



Heavy duty ball bearing runners with soft-close system as standard

Three-dimensional adjustment of the door

Upper shelf in painted steel available as option

Lid with filter available as option

Total load capacity: 60 kg

Installation depth: 485 mm

Installation height: 470 mm

Finishes available (bins/frame):

- Orion/Orion

>□<	300	400	450	500	600
W	264-268	364-368	414-418	464-468	564-568
	TOT 32 L	TOT 48 L	TOT 48 L	TOT 48 L	TOT 72 L

469

Free-standing double bin waste unit with metal cover



Full extension runners with soft-close system
Total load capacity: 30 kg
Fixing position of the runners on the bottom of the cabinet
Bins configuration: 2 x 18 litres (total 36 litres)
Installation width: 335 mm
Installation depth: 490 mm
Installation height: 412 mm

Finishes available (bins/frame):

- Grey/Grey
- Grey/Chrome



484

Free-standing three bins waste unit



Single extension runners with soft-close system

Total load capacity: 25 kg

Fixing position of the runners on the bottom of the cabinet

Bins configuration: 1 x 18 + 2 x 8 litres (total 34 litres)

Installation width: 385 mm

Installation depth: 495 mm

Installation height: 340 mm

Finishes available (bins/frame):

- Grey/Grey

169

Free-standing double bin waste unit with plastic cover



Single extension runners with soft-close system

Total load capacity: 25 kg

The lid opens automatically when pulling out the bin

Fixing position of the runners on the bottom of the cabinet

Bins configuration: 2 x 18 litres (total 36 litres)

Installation width: 330 mm

Installation depth: 485 mm

Installation height: 425 mm

Finishes available (bins/frame):

- Grey/Grey



368

Wastebin for door installation



Bin configuration: 1 x 10 litres

The lid opens automatically when opening the door

Installation width: 250 mm

Installation depth: 250 mm

Installation height: 370 mm

Finishes available (bin):

- Grey

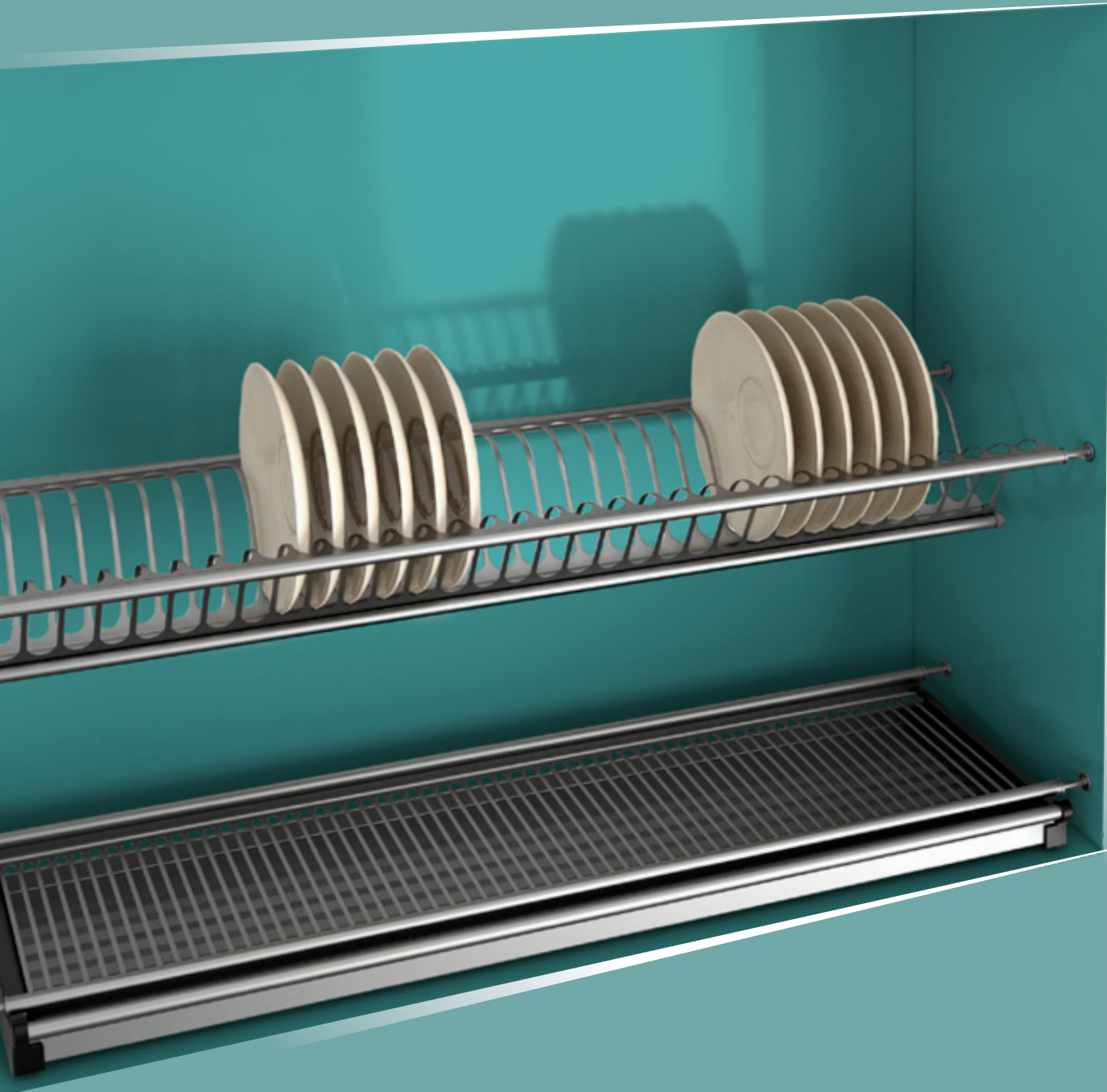

DISH DRAINERS

Designed to put the dishes in their place, they help to keep them tidy and always at hand. The practical drip tray avoids dripping water down, keeping the furniture dry.

453

Dish drainer in stainless steel



Complete kit of rack for dishes, rack for glasses and drip tray
 Made of AISI 201 stainless steel for better corrosion resistance
 Fixing to the cabinet through 10 mm spring dowels
 Installation depth: 245 mm
 Installation height: rack for dishes 105 mm; rack for glasses 50 mm

>□<	W (min-max)
450	395-420
600	545-570
800	745-770
900	845-870



51

Double dish drainer wire racks



Includes one rack for dishes and one rack for glasses
 To be combined with frames and brackets
 To be completed with the drip tray (article 61)
 Installation depth: 232 mm
 Installation height: rack for dishes 57 mm; rack for glasses 30 mm

>□<	W (min-max)
450	414-418
600	564-568
800	764-768
900	864-868

Finishes available (racks):

● Grey ● Coated Nichel ● Chrome

52

Multi-purpose dish drainer wire rack

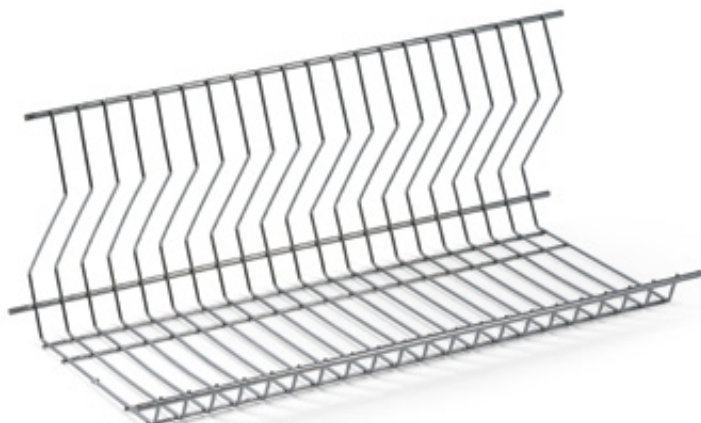

Multipurpose rack for low furniture
 To be combined with frames and brackets
 To be completed with the drip tray (article 61)
 Installation depth: 232 mm
 Installation height: 205 mm

>□<	W (min-max)
450	414-418
600	564-568
800	764-768
900	864-868

Finishes available (racks):

● Grey ● Coated Nichel ● Chrome

61

Drip tray for dish drainers

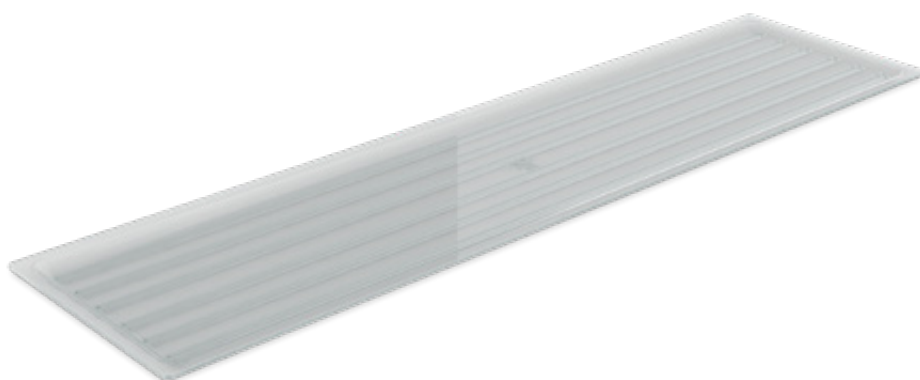

Made of shock-resistant semitransparent polystyrene
 To be combined with frames and brackets
 To be completed with racks (articles 51 and 52)
 Installation depth: 215 mm

>□<	W (min-max)
450	390-394
600	540-544
800	740-744
900	840-844



159

Adjustable aluminium frame for dish drainers



To be completed with racks (articles 51 and 52) and drip tray (article 61)
 Installation depth (min-max): 280-420 mm
 Installation height: 62 mm (frame only)
 On request also available with fixed depth (article 59)

>□<	W
450	414
600	564
800	764
900	864

Finishes available:

- Grey



55-355

Brackets for dish drainers



For the side fixing of the dish drainer racks (articles 51 and 52)
 Version without tray slots (55)
 Version with tray slots (355)
 Installation depth: 271 mm (55) 250 mm (355)
 Installation height: 40 mm (55) 55 mm (355)

Finishes available:

- Grey



Compagnucci High Tech s.r.l.

società a socio unico

Via Scarpara Alta, 57
60030 S.Maria Nuova (AN) Italy
Tel. + 39 0731 245999
Fax +39 0731 082201
info@compagnucci.it

www.compagnucci.it

© Compagnucci High Tech s.r.l. 2021. May 2021.

The data contained in the catalog can include technical inaccuracies or typographical errors and could be changed by the company. Compagnucci High Tech s.r.l. reserves the right to make changes to its products, without notice.

The reproduction of this catalog and products present in it is prohibited.



www.compagnucci.it